

Non-Contact Infrared Thermometers Operating Manual

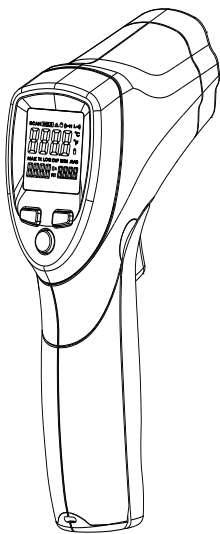

06/08-62B

TABLE OF CONTENTS

INTRODUCTION.....	4
FEATURES.....	4
WIDER ANGE APPLICATION	5
SAFETY.....	5
DISTANCE&SPOTSIZE.....	6
SPECIFICATIONS.....	6
FRONT PANEL DESCRIPTION.....	8
INDICATOR.....	8
BUTTONS.....	9
MEASURMENT OPERATION.....	11
BATTER YREPLACEMENT.....	13
NOTES.....	14
MAINTENANCE	17

INTRODUCTION

Thank you for purchase of the IR Thermometer. This is capable of non-contact(infrared) temperature measurements at the touch of a button. The built-in laser pointer increases target accuracy while the backlight LCD and handy push-buttons combine for convenient, ergonomic operation.

The Non-contact Infrared Thermometers can be used to measure the temperature of objects' surface that is improper to be measured by traditional (contact) thermometer (such as moving object, the surface with electricity current or the objects which are uneasy to be touched.)

Proper use and care of this meter will provide years of reliable service.

FEATURES:

- Rapid detection function
- Precise non-contact measurements
- Dual laser sighting
- Unique flat surface, modern housing design
- Automatic Data Hold
- °C/°F switch
- Emissivity Digitally adjustable from 0.10 to 1.0
- MAX temperature displays

- Backlight LCD display
- Automatic selection range and Display Resolution 0.1°C(0.1°F)
- Trigger lock
- Set high and low alarms

WIDE RANGE APPLICATION:

Food preparation, Safety and Fire inspectors, Plastic molding, Asphalt, Marine and Screen printing, measure ink and Dryer temperature, HVAC/R, Diesel and Fleet maintenance.



SAFETY

- Use extreme caution when the laser beam is turned on.
- Do not let the beam enter your eye, another person's eye or the eye of an animal.
- Be careful no to let the beam on a reflective surface strike your eye.
- Do not allow the laser light beam impinge on any gas which can explode.



Distance & Spot Size

As the distance (D) from the object increases, the spot size (S) of the area measured by the unit becomes larger. The relationship between distance and spot size for each unit is listed below. The focal point for each unit is 914mm (36"). The spot sizes indicate 90% encircled energy.

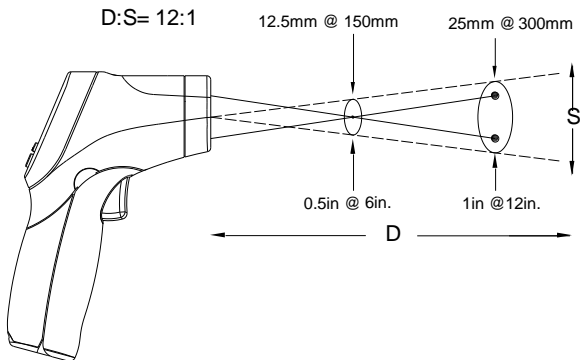

1. SPECIFICATIONS

	Temperature range	D: S
	-50 to 650 °C(-58°F ~ 1202°F)	12:1
Display resolution	0.1 °C(0.1°F)	<1000
	1°F	>1000
Accuracy	for targets:	

Assumes ambient operating temperature of 23 to 25°C(73 to 77°F)

-50 ~ 20°C (-58°F ~ 68°F)	±2.5°C (4.5°F)
20°C ~300°C (68°F ~572°F)	±1.0% ±1.0°C (1.8°F)
300°C ~650°C (572°F ~ 1202°F)	±1.5%

Repeatability

-50~20°C (-58~68°F) : ±1.3°C (2.3°F)

20~650°C (68~1202°F): ±0.5% or ±0.5°C (0.9°F)

Response time 150ms

Spectral response 8~14um

Emissivity Digitally adjustable from 0.10 to 1.0

Over range indication LCD will show “----”

Polarity Automatic (no indication for positive polarity);
Minus (-) sign for negative polarity

Diode laser output <1mW,Wavelength 630~670nm,
Class 2 laser product

Operating temp. 0 to 50°C (32 to 122°F)

Storage temp. -10 to 60°C (14 to 140°F)

Relative humidity 10%~90%RH operating,
<80%RH storage

Power supply 9V battery, NEDA 1604A or IEC 6LR61,
or equivalent

Safety “ CE ” Comply with EMC

Note:

- **Field of View:** Make sure that the target is larger than the unit's spot size. The smaller the target, the closer you should be to it. When accuracy is critical, make sure the target is at least twice as large as the spot size.

2. FRONT PANEL DESCRIPTION

- ① IR sensor
- ② LCD Display Laser pointer beam
- ③ up button
- ④ down button
- ⑤ mode button
- ⑥ Measurement Trigger
- ⑦ Battery Cover
- ⑧ Handle Grip

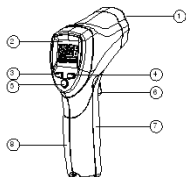

3. INDICATOR

- ① Data hold
- ② Laser "on" symbols
- ③ Lock symbol
- ④ High alarm and low alarm symbol
- ⑤ °C/°F symbol

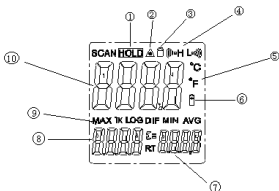

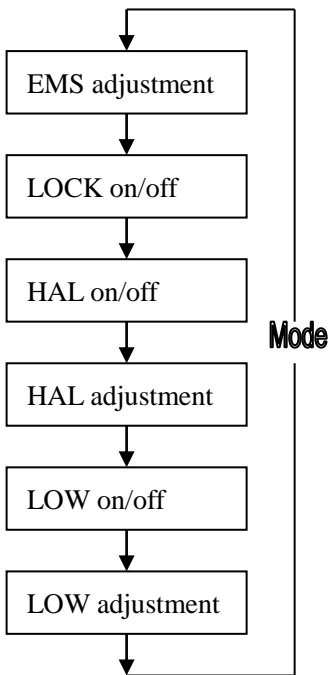

MODE Button Function

Press the mode button also allows you to access the setstate, Emissivity(EMS), Lock on/off, HAL on/off, HAL adjustment LOW on/ off, LOW adjustment, Each time you press set you advance through the mode cycle. The diagram shows the sequence of functions in the mode cycle.

EMS adjustment. The Emissivity(EMS) digitally adjustable from 0.10 to 1.0, LOCK on/off. The lock mode is particularly useful for

continuous monitoring of temperatures. Press the up button or down button to turn on or off . Press the Measurement Trigger to confirm the lock measurement mode. The IR Thermometer will continuously display the temperature until press again the Measurement Trigger.

In lock mode, press the up button or down button adjustable the Emissivity.HAL (LOW) on/off. Press the up button or down button to turn on or turn off. Press the Measurement Trigger to confirm the High(Low)alarm mode.Hal(LOW) adjustment. The high(Low) alarm adjustable form

-50 to 650 °C (-58°F ~ 1202°F)

Switching C/F

Select the temperature units (°C or °F) using the °C/°F switch (①)

Max indicate the max record that displays between the pressing and releasing the "ON/OFF" button each time

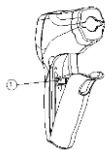

MEASUREMENT OPERATION

- ① Hold the meter by its **Handle Grip** and point it toward the surface to be measured.
- ② Pull and hold the **Trigger** to turn the meter on and begin testing. The display will light if the battery is good. Replace the battery if the display does not light.
- ③ Release the Trigger and the HOLD display icon will

appear on the LCD indicating that the reading is being held. In HOLD status, press the UP button to turn on or off the laser. And press the DOWN button to turn on or off the backlight.

④ The meter will automatically power down after approximately 7 seconds after the trigger is released.(Unless the unit is locked on)

This device is provided with vision alarm function.

During measurement, if the measured temperature is higher than the High Alarm temperature (High Alarm is ON), red LED will flash on the LCD.

During measurement, if the measured temperature is lower than the Low Alarm temperature (Low Alarm is ON), red LED will flash on the LCD.

Note: Measurement considerations

Holding the meter by its handle, point the IR Sensor toward the object whose temperature is to be measured. The meter automatically compensates for temperature deviations from ambient temperature. Keep in mind that

it will take up to 30 minutes to adjust to wide ambient temperatures are to be measured followed by high temperature measurements, some time (several minutes) is required after the low (and before the high) temperature measurements are made.

This is a result of the cooling process, which must take place for the IR sensor.

5. BATTERY REPLACEMENT

① As battery power is not sufficient, LCD will display “” replacement with one new battery type 9V is required.

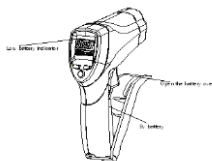

② Open battery cover, then take out the battery from instrument and replace with a new 9-Volt battery and place the battery cover back.

NOTES:

- ***How it Works***

Infrared thermometers measure the surface temperature of an object. The unit's optics sense emitted, reflected, and transmitted energy, which is collected and focused onto a detector. The unit's electronics translate the information into a temperature reading, which is display on the unit. In units with a laser, the laser is used for aiming purposes only.

- ***Field of View***

Make sure that the target is larger than the unit's spot size. The smaller the target, the closer you should be to it. When accuracy is critical, make sure the target is at least twice as large as the spot size.

- ***Distance & Spot Size***

As the distance (D) from the object increases, the spot size (S) of the area measured by the unit becomes larger. See: **Fig: 1**.

- ***Locating a hot Spot***

To find a hot spot aim the thermometer outside the area of interest, then scan across with an up and down motion until you locate hot spot.

- ***Reminders***

- ① Not recommended for use in measuring shiny or polished metal surfaces (stainless steel, aluminum, etc.).See **Emissivity**
- ② The unit cannot measure through transparent surfaces such as glass. It will measure the surface temperature of the glass instead.
- ③ Steam, dust, smoke, etc., Can prevent accurate measurement by obstructing the unit's optics.

- ***Emissivity***

Emissivity is a term used to describe the energy-emitting characteristics of materials.

Most (90% of typical applications) organic materials and painted or oxidized surfaces have an emissivity of 0.95 (pre-set in the unit). Inaccurate readings will result from measuring shiny or polished metal surfaces. To compensate, cover the surface to be measured with masking tape or flat black paint. Allow time for the tape to reach the same temperature as the material underneath it. Measure the temperature of the tape or painted surface.

Emissivity Values

Substance	Thermal emissivity	Substance	Thermal emissivity
Asphalt	0.90 to 0.98	Cloth (black)	0.98
Concrete	0.94	Human skin	0.98
Cement	0.96	Lather	0.75 to 0.80
Sand	0.90	Charcoal (powder)	0.96
Earth	0.92 to 0.96	Lacquer	0.80 to 0.95
Water	0.92 to 0.96	Lacquer (matt)	0.97
Ice	0.96 to 0.98	Rubber (black)	0.94
Snow	0.83	Plastic	0.85 to 0.95
Glass	0.90 to 0.95	Timber	0.90
Ceramic	0.90 to 0.94	Paper	0.70 to 0.94
Marble	0.94	Chromium oxides	0.81
Plaster	0.80 to 0.90	Copper oxides	0.78
Mortar	0.89 to 0.91	Iron oxides	0.78 to 0.82
Brick	0.93 to 0.96	Textiles	0.90

7. MAINTENANCE

- Repairs or service are not covered in this manual and should only be carried out by qualified trained technician.
- Periodically, wipe the body with a dry cloth. Do not use abrasives or solvents on this instrument.
- For service, use only manufacturer's specified parts.



v090105