

Ventouses

V300

Ventouse encastrée 300 kg



V300

CARACTÉRISTIQUES

V300

- 12 VDC / 500 mA
- 24 VDC / 250 mA
- Avec contre-plaque

DIMENSIONS (mm)

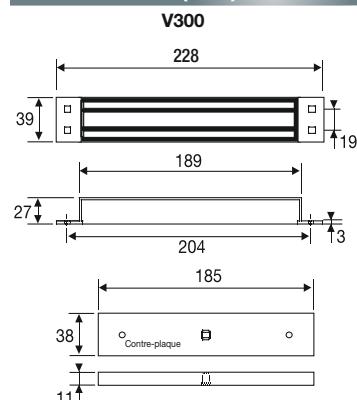

V300SA

Ventouse saillie 300 kg



V300SA

CARACTÉRISTIQUES

V300SA

- 12 VDC / 500 mA
- 24 VDC / 250 mA
- Avec contre-plaque

DIMENSIONS (mm)

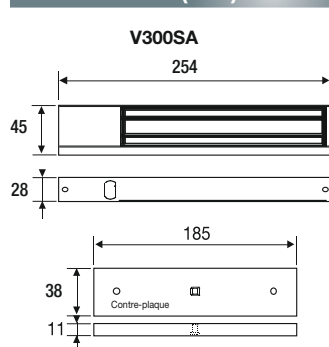

V600SA

Ventouse saillie 500 kg



V600SA

CARACTÉRISTIQUES

V600SA

- 12 VDC / 500 mA
- 24 VDC / 250 mA
- Avec contre-plaque

DIMENSIONS (mm)

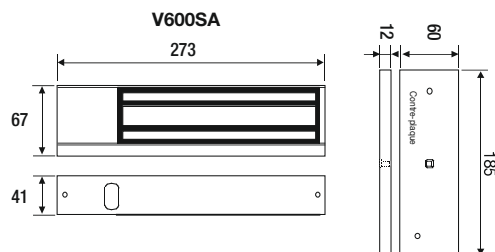

Options de ventouses

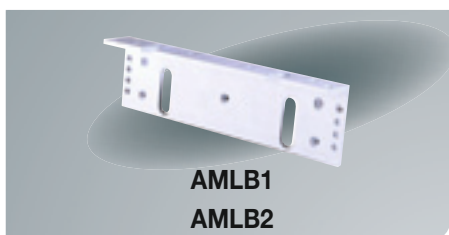

AMLB1
AMLB2



EZ

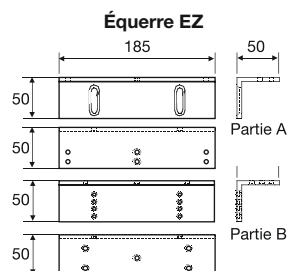
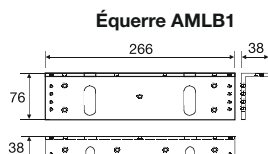
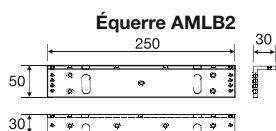

AMLB1

Équerre aluminium en "L" pour ventouse saillie V600SA.

AMLB2

Équerre aluminium en "L" pour ventouse saillie V300SA.

EZ

Équerre aluminium en "Z" (à utiliser avec ALMB1/ALMB2) pour ventouses saillies V300SA et V600SA.

